



Das Beste für Ihre Terrasse

The best choice for your terrace





Vielfalt durch Vielseitigkeit: Schirmvariationen von Tophoven.

Qualität, Funktion und Ästhetik für den unübersehbaren Blickfang auf Terrassen, in Biergärten und Außenanlagen.

Als Schattenspender, Regenschutz oder als persönliche Visitenkarte Ihres erfolgreichen Unternehmens.

TOP-SCHIRME von Tophoven bestehen nicht nur durch Ihre perfekte Form und intelligente Funktion, sondern sie verleihen jederzeit jedem Ort und jeder Marke die gebührende Aufmerksamkeit.

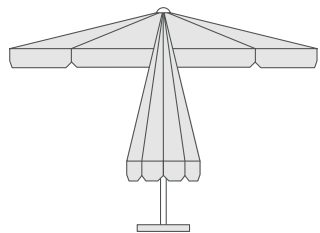

Schirme ohne Teleskop
umbrellas without telescope

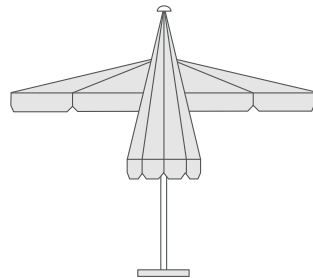

Schirme mit Teleskop
umbrellas with telescope

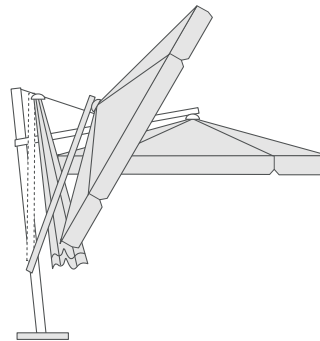

Freiarmschirme
side post umbrellas

Variety and versatility: Umbrella variations from Tophoven.

Quality, function and aesthetics for the unmissable eye-catcher on terraces, in beer gardens and in outdoor facilities.

As sun-shade, rain umbrella or as a personalised symbol of your successful company.

TOP-UMBRELLAS from tophoven do not only attract with their perfect design and intelligent function. They draw the due attention at any time, in any place and to any brand.



04 NIZZA



13 ROYAL EAGLE



26 STORMBREAKER®



36 XXL



40 LIBERTY MX



42 CAPRI



44 BALI



46 BAMBRELLA



54 QUALITÄT
MAßGESCHNEIDERT
Customised quality



55 DRUCKTECHNIK
Printing techniques



56 ELEKTRO
Electrics



57 AUFSTELLVARIANTEN
Bases and stands

NIZZA

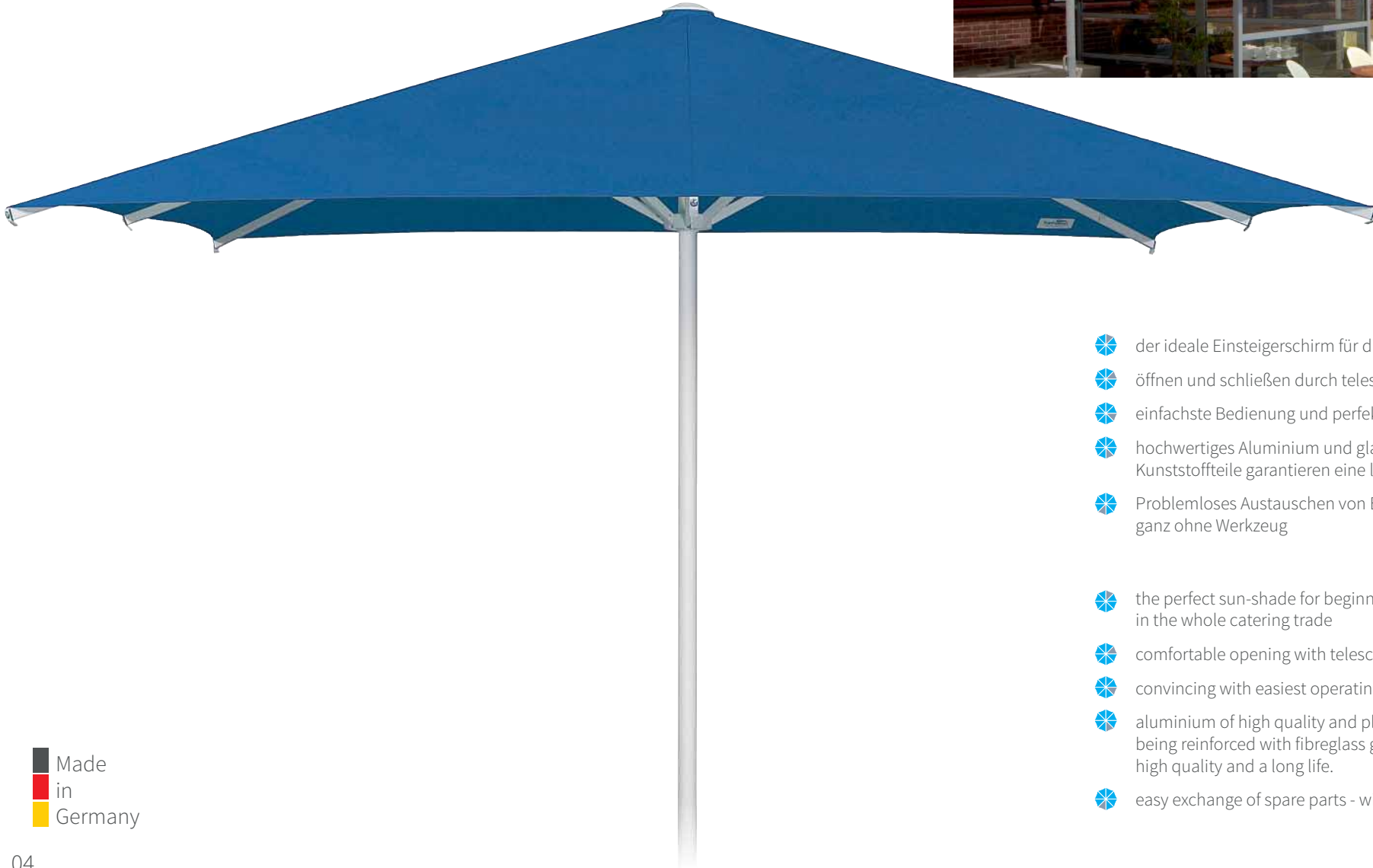

- ❖ der ideale Einsteigerschirm für die gesamte Gastronomie
- ❖ öffnen und schließen durch teleskopisches Schiebesystem
- ❖ einfachste Bedienung und perfekte Funktion
- ❖ hochwertiges Aluminium und glasfaserverstärkte Kunststoffteile garantieren eine lange Lebensdauer
- ❖ Problemloses Austauschen von Ersatzteilen ganz ohne Werkzeug

- ❖ the perfect sun-shade for beginners in the whole catering trade
- ❖ comfortable opening with telescopic sliding system
- ❖ convincing with easiest operating and perfect function
- ❖ aluminium of high quality and plastic parts being reinforced with fibreglass guarantee high quality and a long life.
- ❖ easy exchange of spare parts - without any tools

Made
in
Germany



Der Einsteiger. Der Einstieg in die Komfortklasse - das Schiebesystem mit Teleskop schafft Freiräume und spart Zeit. Mit Streben aus Aluminium.

The entry model. The entry into the comfort class - the sliding system with telescope creates free space and saves time. With supports made of aluminium.

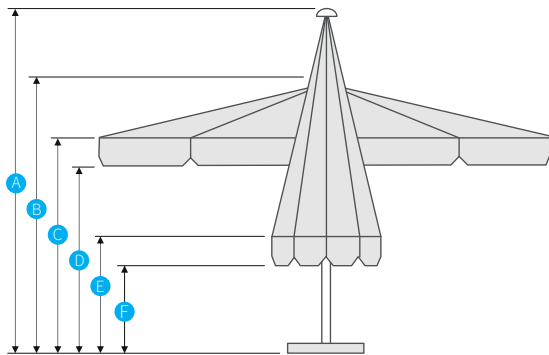

Mobilität mobility					
Windbeständigkeit windpower resistance					
Ausstattung accessories					

Größen und Formen sizes and shapes	Ø 300 cm [7,1 m ²] * 8 Streben arms	Ø 350 cm [9,6 m ²] * 8 Streben arms	Ø 400 cm [12,6 m ²] * 8 Streben arms	Ø 450 cm [15,9 m ²] 8 Streben arms	Ø 500 cm [19,6 m ²] 8 Streben arms
A Höhe geschlossen closed height	345 cm	371 cm	375 cm	410 cm	445 cm
B Höhe geöffnet opened height	280 cm	298 cm	290 cm	325 cm	290 cm
C Durchgangshöhe ohne Volant internal height without valance	230 cm	230 cm	230 cm	230 cm	230 cm
D Durchgangshöhe mit Volant internal height with valance	200 cm	200 cm	200 cm	200 cm	200 cm
E Bodenfreiheit bis Streben geschlossen closed space up to supporting	195 cm	180 cm	167 cm	165 cm	195 cm
F Bodenfreiheit bis Volant geschlossen closed space up to valance	175 cm	160 cm	130 cm	145 cm	170 cm
Gewicht weight	15,0 kg	17,0 kg	21,0 kg	23,0 kg	25,5 kg
alternativ/Optionen: optionally:	* Mast 50 mm mast 50 mm Windhaube airvent				

Mast: Aluminium 60 x 4 mm
 Streben: Aluminium 30 x 19 mm
 Bedienung: Schnellspann-System, teleskopisch
 Bezug: AIRTEX, 100 % Polyester, 195 g/m², WS ca. 800 mm
 ORCHESTRA, 100 % Acryl, 300 g/m², WS ca. 300 mm

Fortsetzung auf Seite 12 ►
continued on side 12

NIZZA



Gaffel am Dom, Köln. Modell: Nizza 350 x 350 cm. Bezugsstoff: Airtex Classic, Farbe 9823 natur.

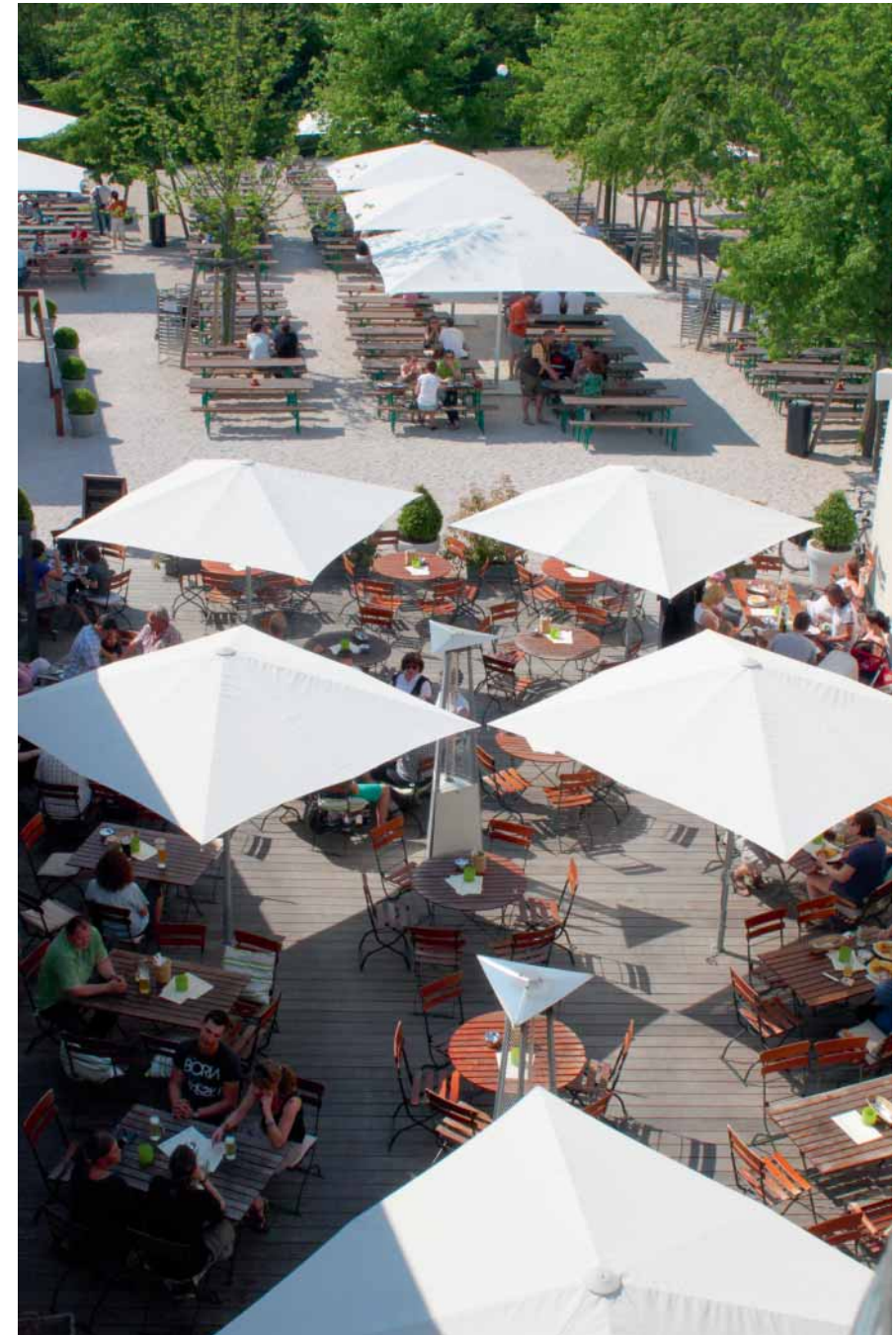

Brauhaus Goldener Engel, Ingelheim.
Modell: Nizza 300 x 300 cm. Bezugsstoff: Airtex Classic, Farbe 9823 natur.

NIZZA





Golfclub Hummelbachau, Neuss. Modell: Nizza 350 x 350 cm. Bezugsstoff: Airtex Classic, Farbe: Weiß 9577.







KiTa Wiesenzauber, Kevelaer. Modell: Nizza 300 x 300 cm. Bezugsstoff: Airtex Classic, Farben: Hellrot 9671, Smaragdgrün 9767, Gelb 9526 und Lagune 9793.

NIZZA



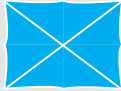

Größen und Formen sizes and shapes	 300 cm [9 m ²] * 8 Streben arms	 350 cm [12,3 m ²] * 8 Streben arms	 400 cm [16 m ²] 8 Streben arms	 200 x 300 cm [6 m ²] 8 Streben arms	 300 x 400 cm [12 m ²] 8 Streben arms
A Höhe geschlossen closed height	360 cm	380 cm	425 cm	360 cm	435 cm
B Höhe geöffnet opened height	285 cm	305 cm	310 cm	275 cm	305 cm
C Durchgangshöhe ohne Volant internal height without valance	230 cm	230 cm	230 cm	200 cm	230 cm
D Durchgangshöhe mit Volant internal height with valance	200 cm	200 cm	200 cm	180 cm	200 cm
E Bodenfreiheit bis Streben geschlossen closed space up to supporting	137 cm	124 cm	135 cm	175 cm	175 cm
F Bodenfreiheit bis Volant geschlossen closed space up to valance	105 cm	100 cm	110 cm	155 cm	150 cm
Gewicht weight	18,0 kg	20,0 kg	24,0 kg	16,0 kg	22,0 kg
alternativ/Optionen: optionally:	* Mast 50 mm mast 50 mm Windhaube airvent				



mast: aluminium 60 x 4 mm
 arms: aluminium 30 x 19 mm
 handling: Quick-open system, telescopic
 cover: AIRTEX, 100 % Polyester, 195 g/m², WC ca. 800 mm
 ORCHESTRA, 100 % Acryl, 300 g/m², WC ca. 300 mm

Other sizes on demand. All sizes are approximately. WC = water column

ROYAL EAGLE



Made
in
Germany

- ❖ der „Perfekte“ für Gastronomie, Restaurants oder Hotels
- ❖ kinderleichte Bedienung durch Schnellspann-System
- ❖ öffnet und schließt teleskopisch
- ❖ hochwertiges Aluminium
- ❖ glasfaserverstärkte Kunststoffteile





- ❖ the „perfect“ symbiosis of aesthetics, function, operating and quality
- ❖ Quick-open system makes operating really easy
- ❖ opens and closes telescopically
- ❖ high-grade aluminium
- ❖ fibreglass reinforced plastic parts

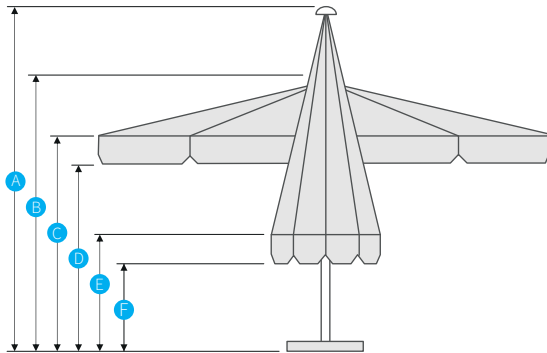

Die Königsklasse.
Spezialprofile aus Aluminium sorgen für die perfekte Symbiose aus Ästhetik, Komfort und Stabilität. Überzeugend!

The King of shade.
Special aluminium profiles provide the perfect combination of aesthetics, convenience and stability. Magnificent!











						
Größen und Formen sizes and shapes	Ø 350 cm [9,6 m ²] 8 Streben arms	Ø 400 cm [12,6 m ²] 8 Streben arms	Ø 450 cm [15,9 m ²] 8 Streben arms	Ø 500 cm [19,6 m ²] 8 Streben arms	Ø 550 cm [23,8 m ²] 8 Streben arms	Ø 600 cm [28,3 m ²] 8 Streben arms
A Höhe geschlossen closed height	371 cm	402 cm	415 cm	450 cm	445 cm	460 cm
B Höhe geöffnet opened height	305 cm	320 cm	320 cm	340 cm	338 cm	350 cm
C Durchgangshöhe ohne Volant internal height without valance	230 cm	230 cm	230 cm	230 cm	230 cm	230 cm
D Durchgangshöhe mit Volant internal height with valance	200 cm	200 cm	200 cm	200 cm	200 cm	200 cm
E Bodenfreiheit bis Streben geschlossen closed space up to supporting	173 cm	183 cm	174 cm	180 cm	161 cm	147 cm
F Bodenfreiheit bis Volant geschlossen closed space up to valance	153 cm	158 cm	154 cm	155 cm	141 cm	127 cm
Gewicht weight	30,5 kg	32,0 kg	34,5 kg	35,0 kg	38,0 kg	40,0 kg
alternativ/Optionen: optionally:	Kurbelgetriebe winder system Windhaube airvent					

Mobilität mobility	
Windbeständigkeit windpower resistance	
Ausstattung accessories	

Mast: Aluminium 70 x 5 mm (geöffnet)
 Streben: Aluminium 43 / 32 x 19 mm
 Bedienung: Schnellspann-System, teleskopisch
 Bezug: AIRTEX, 100 % Polyester, 195 g/m² WS ca. 800 mm
 ORCHESTRA, 100 % Acryl, 300 g/m², WS ca. 300 mm

Abweichende Abmessungen auf Anfrage. Alle Maße sind Circa-Maße. WS = Wassersäule



 □ 300 cm [9 m ²] 8 Streben arms	 □ 350 cm [12,3 m ²] 8 Streben arms	 □ 400 cm [16 m ²] 8 Streben arms	 □ 450 cm [20,3 m ²] 8 Streben arms	 □ 500 cm [25 m ²] 8 Streben arms	 □ 250 x 400 cm [15 m ²] 8 Streben arms	 □ 300 x 500 cm [15 m ²] 8 Streben arms	 □ 350 x 400 cm [15 m ²] 8 Streben arms	 □ 400 x 500 cm [20 m ²] 8 Streben arms
375 cm	368 cm	420 cm	435 cm	485 cm	419 cm	435 cm	409 cm	440 cm
300 cm	291 cm	320 cm	330 cm	338 cm	301 cm	310 cm	301 cm	320 cm
230 cm	230 cm	230 cm	230 cm	230 cm	230 cm	230 cm	230 cm	230 cm
200 cm	200 cm	200 cm	200 cm	200 cm	200 cm	200 cm	200 cm	200 cm
153 cm	111 cm	123 cm	103 cm	124 cm	181 cm	132 cm	144 cm	114 cm
133 cm	91 cm	103 cm	83 cm	104 cm	156 cm	112 cm	124 cm	94 cm
32,0 kg	35,0 kg	38,0 kg	42,0 kg	48,0 kg	34,0 kg	38,0 kg	36,0 kg	44,0 kg

mast: aluminium 70 x 5 mm (open)
 arms: aluminium 43 / 32 x 19 mm
 handling: Quick-open system, telescopic
 cover: AIRTEX, 100 % Polyester, 195 g/m², WC ca. 800 mm
 ORCHESTRA, 100 % Acryl, 300 g/m², WC ca. 300 mm

Other sizes on demand. All sizes are approximately. WC = water column

ROYAL EAGLE







Club Astoria, Köln. Modell: Royal Eagle 500 x 500 cm. Bezugsstoff: Airtex PrintMagic. Farbe: Weiß.

ROYAL EAGLE





ROYAL EAGLE



Krankenhaus St. Franziskus, Mönchengladbach. Modell: Royal Eagle 400 x 400 cm. Bezugsstoff: Dickson Orchestra, Farbe: Taupe 7559.



ROYAL EAGLE



ROYAL EAGLE





Pension Hubertus, Bad Reichenhall. Modell: Royal Eagle 300 x 300 cm, 400 x 500 cm und 400 cm rund. Bezugsstoff: Dickson Orchestra, Farbe: U239 sunset.

STORMBREAKER®









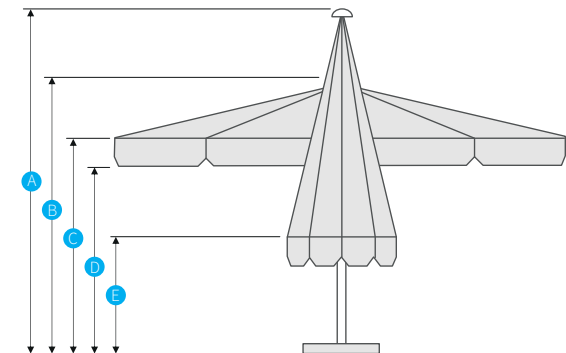

Made
in
Germany













- Der ultimative Allwetter-Großschirm. Widersteht Windböen von bis zu 100 km/h!
- Heizstrahler können abgeklappt werden, sodass diese beim Schließen des Schirms nicht abgenommen werden müssen
- Maximale Möbelfreiheit für noch mehr Komfort, gerade in der Gastronomie.
- Bewährtes Kurbelgetriebe, sicher und kinderleicht zu bedienen.
- The ultimate parasol for any weather! Capable of withstanding wind speeds of up to 100 km/h!
- Heaters can be folded down, so that they can remain inside the parasol when closing it
- Operating leaves even more space for furniture below the parasol.
- Approved winder system for safe and easy handling.





Größen und Formen sizes and shapes	 Ø 600 cm [28 m ²] 12 Streben arms	 Ø 700 cm [38 m ²] 12 Streben arms	 Ø 800 cm [59 m ²] 12 Streben arms	 450 cm [22,5 m ²] 12 Streben arms	 500 cm [25 m ²] 12 Streben arms	 600 cm [36 m ²] 12 Streben arms	 400 x 500 cm [20 m ²] 10 Streben arms	 400 x 600 cm [24 m ²] 10 Streben arms	 500 x 600 cm [30 m ²] 12 Streben arms
A Höhe geschlossen closed height	487 cm	516 cm	550 cm	474 cm	497 cm	536 cm	469 cm	490 cm	508 cm
B Höhe geöffnet opened height	345 cm	367 cm	383 cm	335 cm	344 cm	362 cm	325 cm	334 cm	344 cm
C Durchgangshöhe ohne Volant internal height without valance	240 cm	245 cm	245 cm	245 cm	245 cm	245 cm	240 cm	245 cm	245 cm
D Durchgangshöhe mit Volant internal height with valance	210 cm	215 cm	215 cm	215 cm	215 cm	215 cm	210 cm	215 cm	215 cm
E Bodenfreiheit bis Streben geschlossen closed space up to supporting	171 cm	148 cm	128 cm	145 cm	132 cm	98 cm	143 cm	121 cm	107 cm
Maximale Windstärke (nach Beaufort) maximum wind force (Beaufort)	10	8	8	10	10	8	10	10	8
Gewicht weight	110,0 kg	124,0 kg	139,0 kg	75,0 kg	82,0 kg	109,0 kg	79,0 kg	70,0 kg	88,0 kg

Mobilität mobility	    
Windbeständigkeit windpower resistance	    
Ausstattung accessories	    

Mast: Aluminium 110 x 5 mm
 Streben: Aluminium 45 x 25 mm / 56 x 31 mm
 Bedienung: Handkurbel/Hubspindel, teleskopisch
 Bezug: ORCHESTRA, 100 % Acryl, 300 g/m², WS ca. 300 mm

mast: aluminium 110 x 5 mm
 arms: aluminium 45 x 25 mm / 56 x 31 mm
 handling: winder-system / telescope
 cover: ORCHESTRA, 100 % Acryl, 300 g/m², WC ca. 300 mm

STORMBREAKER®



Golfclub ETUF, Essen. Modell: Stormbreaker 600 x 600 cm, Bezugsstoff: Dickson Orchestra, Farbe 8203 ardoise.



Privat, Potsdam. Modell: Stormbreaker 500 x 500 cm, Bezugsstoff: Dickson Orchestra, Farbe 7133 naturel.





Eisbar, Mühlheim an der Ruhr. Modell: Stormbreaker 400 x 600 cm. Bezugsstoff: Dickson Orchestra, Farbe: Noisette 6025.

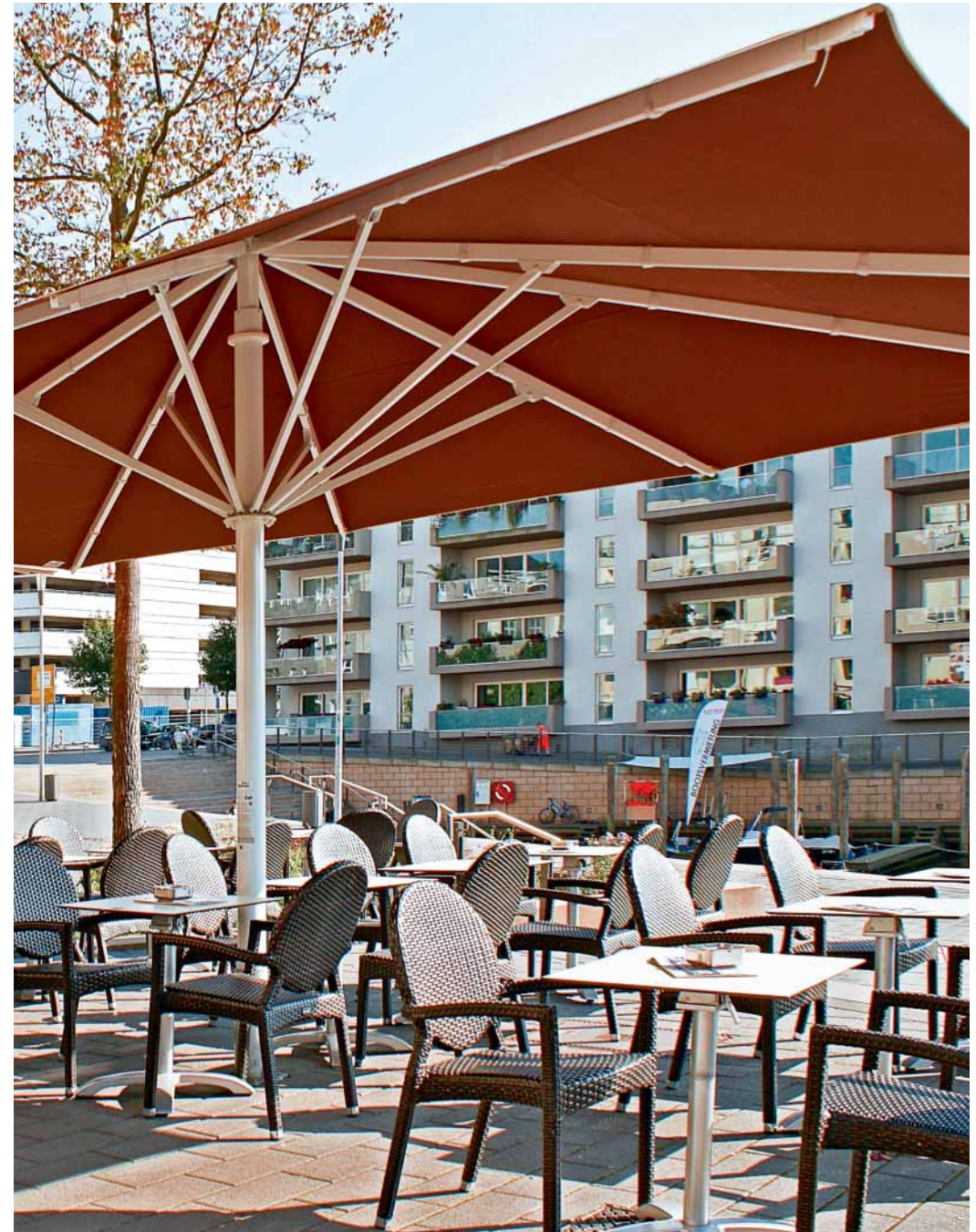



STORMBREAKER®



Brauerei Jöris, Mönchengladbach. Modell: Stormbreaker 800 cm. Bezugsstoff: Dickson Orchestra, Farbe: Forret 6687.

STORMBREAKER®





Rheinterrassen Baumberg, Monheim. Modell: Stormbreaker 500 x 500 cm. Bezugsstoff: Dickson Orchestra, Farbe: Carbone U171.

XXL









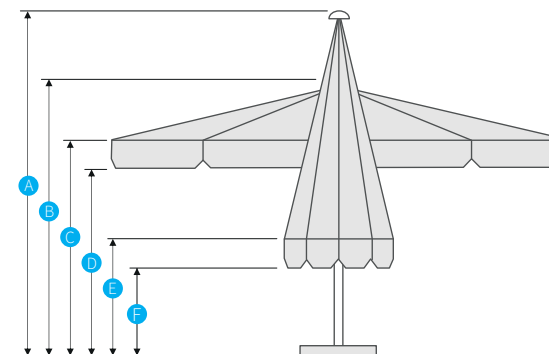

Made
in
Germany











- Der wahrhaftige Riese unter den Sonnenschirmen. Ein Schirm - und die Terrasse ist überdacht!
- Heizstrahler können abgeklappt werden, sodass diese beim Schließen des Schirms nicht abgenommen werden müssen
- robust und strapazierfähig
- kinderleichte Bedienung durch Kurbelsystem
- A true giant among the sunshades. One umbrella - and your whole terrace is covered!
- Heaters can be folded down, so that they can remain inside the parasol when closing it
- robust and hard-wearing
- feather-light crank system for easy handling





Größen und Formen sizes and shapes	 Ø 900 cm [63,6 m ²] 12 Streben arms	 Ø 1000 cm [78,6 m ²] 12 Streben arms	 □ 700 cm [49 m ²] 12 Streben arms	 □ 500 x 800 cm [40 m ²] 10 Streben arms	 □ 500 x 900 cm [45 m ²] 10 Streben arms	 □ 600 x 700 cm [42 m ²] 10 Streben arms	 □ 600 x 800 cm [48 m ²] 10 Streben arms	 □ 700 x 800 cm [56 m ²] 10 Streben arms
A Höhe geschlossen closed height	515 cm	550 cm	530 cm	510 cm	550 cm	535 cm	526 cm	560 cm
B Höhe geöffnet opened height	400 cm	420 cm	420 cm	365 cm	380 cm	385 cm	383 cm	425 cm
C Durchgangshöhe ohne Volant internal height without valance	260 cm	260 cm	280 cm	275 cm	280 cm	270 cm	275 cm	280 cm
D Durchgangshöhe mit Volant internal height with valance	230 cm	230 cm	250 cm	245 cm	250 cm	240 cm	250 cm	255 cm
E Bodenfreiheit bis Streben geschlossen closed space up to supporting	50 cm	35 cm	40 cm	40 cm	45 cm	75 cm	55 cm	35 cm
F Bodenfreiheit bis Volant geschlossen closed space up to valance	35 cm	20 cm	25 cm	25 cm	20 cm	50 cm	30 cm	10 cm
Gewicht weight	125,0 kg	150,0 kg	125,0 kg	115,0 kg	135,0 kg	115,0 kg	145,0 kg	169,0 kg

Mobilität mobility	    
Windbeständigkeit windpower resistance	    
Ausstattung accessories	    

Mast: Aluminium 110 x 5 mm
 Streben: Aluminium 45 x 25 mm / 56 x 31 mm
 Bedienung: Handkurbel/Hubspindel - gegenteleskopierend
 Bezug: ORCHESTRA, 100 % Acryl, 300 g/m², WS ca. 300 mm

mast: aluminium 110 x 5 mm
 arms: aluminium 45 x 25 mm / 56 x 31 mm
 handling: winder-system / double telescope
 cover: ORCHESTRA, 100 % Acryl, 300 g/m², WC ca. 300 mm

XXL



Tagungshotel Maria in der Aue, Wermelskirchen. Modell: XXL 9 m und 7 m rund. Bezugsstoff: Dickson Orchestra, Farbe 0001 ecru.



Wimbledon, England. Modell: XXL 10 m rund. Bezugsstoff: Dickson Orchestra, Farbe 0001 ecru.

LIBERTY MX



- ❖ Der Freiarmschirm für professionelle Ansprüche!
- ❖ Schafft Freiraum, besonders für kleine und mittlere Terrassen
- ❖ Leichte Bedienbarkeit mit Handkurbel
- ❖ Robuste Verarbeitung und hohe Windfestigkeit
- ❖ Modernes Design im matt strukturiertem Finish
- ❖ Einzeln verschraubte Teile ermöglichen den einfachen Austausch von Ersatzteilen oder des Schirmbezugs
- ❖ The cantilever parasol for professional demands
- ❖ Creates free space, especially for small and medium sized terraces
- ❖ Easy operating with crank handle
- ❖ Robust structure with high wind resistance
- ❖ Contemporary design with a matte structured finish
- ❖ Spare parts and canopies can be replaced individually



Scharniere einzeln verschraubt.
Hinges are bolted separately.



Die Windhaube kann auf Wunsch in einer Kontrastfarbe gefertigt werden.
On demand, the airvent can be ordered in a contrast colour.



Der Freiarmschirm LIBERTY MX schafft Freiräume und eignet sich aufgrund seiner besonderen Geometrie auch für Terrassen mit einer geringen bis mittleren Bautiefe. Außerdem überzeugt er durch eine hohe Windfestigkeit und eine leichte Bedienbarkeit.

The cantilever parasol LIBERTY MX helps you creating free space, and is especially suitable for small and medium sized terraces. Furthermore, its wind resistance and easy operating are just convincing.

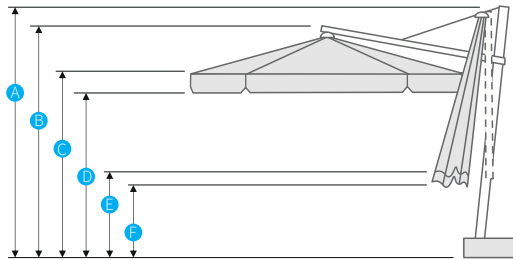

Mobilität mobility					
Windbeständigkeit windpower resistance					
Ausstattung accessories					

Größen und Formen sizes and shapes	 Ø 350 cm [9,6 m ²] 8 Streben arms	 □ 300 cm [9 m ²] 8 Streben arms	 □ 350 cm [12,3 m ²] 8 Streben arms	 □ 400 cm [16 m ²] 8 Streben arms	 □ 300 x 400 cm [12 m ²] 8 Streben arms
A Höhe geschlossen closed height	314 cm	290 cm	323 cm	321 cm	297 cm
B Höhe geöffnet opened height	310 cm	321 cm	319 cm	330 cm	305 cm
C Durchgangshöhe ohne Volant internal height without valance	220 cm	222 cm	221 cm	237 cm	230 cm
D Durchgangshöhe mit Volant internal height with valance	190 cm	192 cm	191 cm	207 cm	200cm
E Bodenfreiheit bis Streben geschlossen closed space up to supporting	62 cm	74 cm	71 cm	31 cm	38 cm
F Bodenfreiheit bis Volant geschlossen closed space up to valance	32 cm	44 cm	41 cm	1 cm	8 cm
Gewicht weight	54 kg	54 kg	56 kg	61 kg	55 kg
alternativ/Optionen: optionally:	Schirmgestell in anthrazit pulverbeschichtet Frame powdercoated in anthracite colour				

Mast: Aluminium 110 x 140 mm, Tragarm 60 x 120 mm
 Streben: Aluminium 20 x 35 mm, Wandstärke 2 mm
 Gestellfarben: weiß oder anthrazit pulverbeschichtet, matt strukturiert
 Bedienung: Kurbelgetriebe
 Bezug: ORCHESTRA, 100 % Acryl, 300 g/m², WS ca. 300 mm

mast: aluminium 110 x 140 mm, carrying arm 60 x 120 mm
 arms: aluminium 20 x 35 mm, wall thickness 2 mm
 frame colour: White or anthracite powder coated, matte structured finish
 handling: Winder system
 cover: ORCHESTRA, 100 % Acryl, 300 g/m², WC app. 300 mm

CAPRI



Made
in
Germany

- ✦ hochwertiges Fiberglas
- ✦ Problemloses Austauschen von Schirmbezügen oder Ersatzteilen ohne Werkzeug
- ✦ 3 Jahre Garantie auf Gestell und Funktion







- ✦ high quality fibreglass
- ✦ easy replacement of covers or spare parts without need for tools
- ✦ 3 year guarantee on frame and function

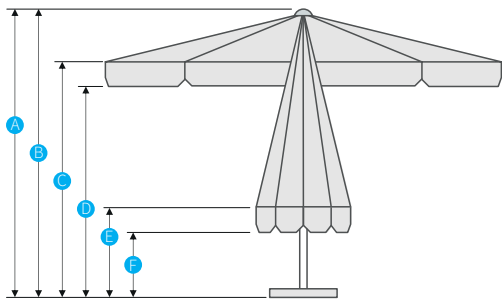

Strapazierfähiger Schirm mit einteiligem Alumast und Streben aus massivem Fiberglas. Leicht, biegsam und „unverwüstlich stabil“.

Durable umbrella with one-piece aluminium pole and supports made of solid fibreglass. Light, flexible and „indestructibly“ stable.



Größen und Formen sizes and shapes	 Ø 250 cm [4,9 m ²] 8 Streben arms	 Ø 300 cm [7,1 m ²] 8 Streben arms	 Ø 350 cm [9,6 m ²] 8 Streben arms	 □ 200 cm [4 m ²] 4 Streben arms	 □ 250 cm [6,3 m ²] 8 Streben arms	 □ 300 cm [9 m ²] 8 Streben arms
A Höhe geschlossen closed height	270 cm	270 cm	260 cm	250 cm	273 cm	290 cm
B Höhe geöffnet opened height	270 cm	270 cm	260 cm	250 cm	273 cm	290 cm
C Durchgangshöhe ohne Volant internal height without valance	225 cm	225 cm	225 cm	210 cm	225 cm	225 cm
D Durchgangshöhe mit Volant internal height with valance	200 cm	200 cm	200 cm	190 cm	200 cm	200 cm
E Bodenfreiheit bis Streben geschlossen closed space up to supporting	130 cm	110 cm	80 cm	100 cm	95 cm	75 cm
F Bodenfreiheit bis Volant geschlossen closed space up to valance	110 cm	90 cm	60 cm	80 cm	70 cm	50 cm
Gewicht weight	9,0 kg	10,0 kg	12,0 kg	12,5 kg	14,5 kg	18,0 kg
alternativ/Optionen: optionally:	Mast 50 mm mast 50 mm					

Mobilität mobility	    
Windbeständigkeit windpower resistance	    
Ausstattung accessories	    

Mast: Aluminium 40 oder 50 mm
 Streben: Fiberglas 8 mm
 Bedienung: Schieber
 Bezug: AIRTEX, 100 % Polyester, 195 g/m², WS ca. 800 mm

mast: aluminium 40 or 50 mm
 arms: fibreglass 8 mm
 handling: slider
 cover: AIRTEX, 100 % Polyester, 195 g/m², WC ca. 800 mm

BALI



- ❖ Gastroschirm mit Aluminiumstreben
- ❖ einfache Bedienung mit Seilzugsystem
- ❖ robuste und strapazierfähige Konstruktion
- ❖ hochwertige Verarbeitung
- ❖ problemloses Austauschen von Ersatzteilen und Schirmbezügen ohne Werkzeug

- ❖ parasol with aluminium ribs
- ❖ easy to use pulley-system
- ❖ robust and hard-wearing
- ❖ high quality finish
- ❖ easy replacement of spare parts or umbrella covers without need for tools

Made
in
Germany



Streben wahlweise aus Aluminium oder Fiberglas, Verbindungen aus GFK aluminium or fibreglass supportings, GPR connectors



Seilzug mit Umlenkrolle pulley-system

Ihre Visitenkarte. Unser Gastro- und Werbeschirm mit Seilzug und benutzerfreundlichem Stecksystem. Da braucht man kein Werkzeug! Mit einem Mast aus Aluminium und Streben aus Aluminium oder Fiberglas = die robuste Vielfalt.

Your business card. Our catering trade and advertising umbrella with cable winch and user-friendly connection system. No tools required! With aluminium pole and fibreglass or aluminium supports = the robust variety.

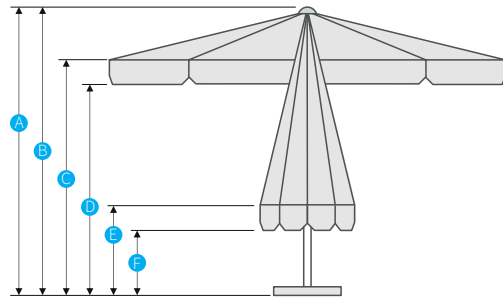

Mobilität mobility					
Windbeständigkeit windpower resistance					
Ausstattung accessories					

Größen und Formen sizes and shapes	Ø 300 cm [7,1 m ²] 8 Streben arms	Ø 350 cm [9,6 m ²] 8 Streben arms	Ø 400 cm [12,6 m ²] 8 Streben arms	□ 250 cm [6,3 m ²] 4 Streben arms	□ 300 cm [9 m ²] 8 Streben arms	□ 350 cm [12,3 m ²] 8 Streben arms
A Höhe geschlossen closed height	260 cm	280 cm	305 cm	275 cm	295 cm	300 cm
B Höhe geöffnet opened height	260 cm	280 cm	305 cm	275 cm	295 cm	300 cm
C Durchgangshöhe ohne Volant internal height without valance	230 cm	230 cm	230 cm	230 cm	230 cm	230 cm
D Durchgangshöhe mit Volant internal height with valance	210 cm	210 cm	210 cm	210 cm	210 cm	210 cm
E Bodenfreiheit bis Streben geschlossen closed space up to supporting	95 cm	95 cm	95 cm	92 cm	75 cm	50 cm
F Bodenfreiheit bis Volant geschlossen closed space up to valance	75 cm	75 cm	75 cm	72 cm	60 cm	30 cm
Gewicht weight	13,5 kg	15,5 kg	17,4 kg	15,0 kg	18,5 kg	21,5 kg

Mast: Aluminium 50 x 2 mm
 Streben: Aluminium 30 x 19 mm oder Fiberglas 10 x 20 mm
 Bedienung: Seilzugsystem
 Bezug: AIRTEX, 100 % Polyester, 195 g/m², WS ca. 800 mm
 ORCHESTRA, 100 % Acryl, 300 g/m², WS ca. 300 mm

mast: aluminium 50 x 2 mm
 arms: aluminium 30 x 19 mm or fibreglass 10 x 20 mm
 handling: pulley-system
 cover: AIRTEX, 100 % Polyester, 195 g/m², WC ca. 800 mm
 ORCHESTRA, 100 % Acryl, 300 g/m², WC ca. 300 mm

BAMBRELLA

Bambus – Wie für uns geschaffen.
Der natürliche Rohstoff der Zukunft. Für eine grünere Welt.

WARUM BAMBRELLA?

- ❁ 5 Jahre Garantie auf Gestell, Armaturen und Technik
- ❁ Außergewöhnliches Design und ausgefeilte, benutzerfreundliche Technik
- ❁ Extrem wetterfest und windstabil (windkanalgetestet bis min. 90 km/h)
- ❁ Feinste Verarbeitung dank langjähriger Erfahrung in der Verarbeitung von Holz
- ❁ Einzigartiges Laminierungsverfahren für Bambus
- ❁ Spezielles, natürliches Finish für ein natürliches Holzgefühl
- ❁ Perfekt abgerundet mit hochwertigen Komponenten aus dem Segelsport
- ❁ Schutz vor Sonne (UPF 50+) und Regen

WHY CHOOSE BAMBRELLA?

- ❁ 5 year guarantee on the frame, fittings and mechanism
- ❁ Patented design and sophisticated, user-friendly mechanism
- ❁ Extremely wind and weather-proof (tested to at least 90 km/h in a wind tunnel)
- ❁ Top-quality finishing thanks to years of experience in working with wood.
- ❁ Unique bamboo lamination process
- ❁ Special natural finish for a natural wood feeling
- ❁ Perfectly completed with high-quality components from the world of sailing
- ❁ Protection against sun (UPF 50+) and rain



Für maximalen Freiraum. Der Sidewind.

Der stärkste Seitenarmschirm. Natürlich von Bambrella.

- ❁ Kronen und Läufer aus gedrehtem Bambuslaminat für höchste Belastbarkeit
- ❁ Drehbar um die eigene Achse sowie nach vorn oder hinten neigbar für optimale Beschattung um bei jedem Sonnenstand
- ❁ Schirmbezug zur Reinigung mit wenigen Handgriffen abnehmbar
- ❁ Beschläge, Verbinder und Endstücke aus Edelstahl
- ❁ Alle Teile verschraubt und einzeln austauschbar

- ❁ Hubs and runners are made from laminated bamboo for maximum strength
- ❁ The parasol can be turned around and adjusted to achieve a fall of the shadow
- ❁ Canvases can be taken off easily for cleaning or replacement
- ❁ Hinges and connectors made from stainless steel
- ❁ All parts can be replaced separately



BAMBRELLA LEVANTE



- ❖ Revolutionäre Haltbarkeit.
Windkanal-getestet bis zu 90 km/h!
- ❖ Natürliche Eleganz sorgt für ein Ambiente zum Wohlfühlen und Genießen.
- ❖ Ausgereifte Technik in modernem Gewand
- ❖ Bambus als nachhaltiger, hochregenerativer Werkstoff – für eine grünere Welt

- ❖ Extremely durable.
Wind channel tested at a max. windspeed of 90 km/h
- ❖ High quality finish in warm golden colours creates a naturally elegant charisma
- ❖ Perfected classic mechanics in a contemporary design
- ❖ Bamboo is environmentally friendly and highly regenerative – for a greener world

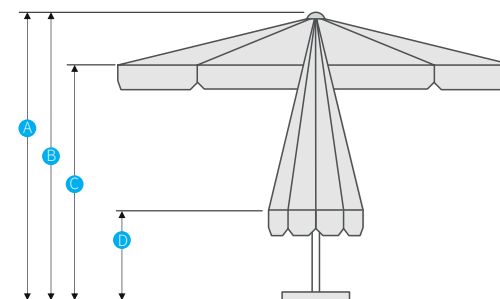



Größen und Formen sizes and shapes	 Ø 250 cm	 Ø 300 cm	 Ø 350 cm	 Ø 400 cm	 □ 210 cm	 □ 260 cm	 □ 300 cm	 □ 340 cm	 □ 200 x 300 cm	 □ 250 x 350 cm
A Höhe geschlossen closed height	265 cm	270 cm	280 cm	280 cm	275 cm	290 cm	293 cm	337 cm	288 cm	300 cm
B Höhe geöffnet opened height	265 cm	270 cm	280 cm	280 cm	275 cm	290 cm	293 cm	337 cm	288 cm	300 cm
C Durchgangshöhe internal height	210 cm	210 cm	210 cm	210 cm	213 cm	226 cm	226 cm	242 cm	210 cm	213 cm
D Bodenfreiheit geschlossen closed space	124 cm	105 cm	89 cm	89 cm	110 cm	86 cm	80 cm	80 cm	92 cm	76 cm
Gewicht weight	12,0 kg	17,0 kg	22,0 kg	26,0 kg	11,0 kg	19,0 kg	23,0 kg	28,0 kg	16,0 kg	26,0 kg

Mobilität
mobility



Windbeständigkeit
windpower resistance



Ausstattung
accessories



Material: Bambusholz, laminiert, Beschläge aus Edelstahl
 Bedienung: Seilzugsystem mit Sicherungsdorn
 Bezug: SPUNCRYLIC, 100 % Polyester, ca. 240 g/m²,
 wasserabweisend imprägniert

material: Bamboo, laminated, brackets and connectors: stainless steel
 handling: pulley system
 cover: SPUNCRYLIC, 100 & Polyester, app. 240 g/m²,
 water-repellant coating



First Class Garden, Nettetal-Hinsbeck. Modell: Bambrella Levante 400 cm. Bezugsstoff: Spuncrylic, Farbe: Taupe SP-08040.

BAMBRELLA LEVANTE



BAMBRELLA LEVANTE





Qualität maßgeschneidert Customised quality



Ebenso individuell wie Ihr Ambiente sind auch unsere Schirme. Daher bieten wir besonders im textilen Bereich eine Vielzahl an Ausstattungsmöglichkeiten. Von klassisch bis modern, von dezent bis auffallend - Sie haben die Wahl.

FARBEN

Sie können die Farbgebung für jeden Schirm frei wählen. Wählen Sie aus über 100 Farben und Farbkombinationen. Gerne übersenden wir Ihnen unsere Stoffmusterkarten. Hier nur ein kleiner Auszug unseres umfangreichen Lagerprogramms. Darüber hinaus können Stoffe auch in jedem beliebigen Farbton eingefärbt werden.

REGENRINNEN

Mit unseren textilen Regenrinnen können Sie Schirme der Baureihen ROYAL EAGLE und XXL miteinander verbinden, um so einen lückenlosen Schutz gegen Regen und Sonne zu erzielen.

SEITENWÄNDE

Auf Wunsch können Schirme der Baureihen ROYAL EAGLE und XXL mit textilen Seitenwänden aus Schirmstoff versehen werden. Auch unsere Seitenwände werden individuell gefertigt, sodass Sie beispielsweise Art und Größe von Sichtfenstern selbst bestimmen.

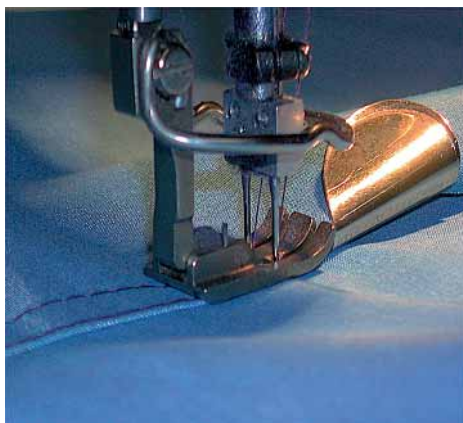

SCHUTZHÜLLEN

aus hochwertigem Airtex bieten Ihren Schirmen optimalen Schutz vor Wind und Wetter, besonders bei ganzjährigem Außeneinsatz. Unsere Schutzhüllen werden für jede Schirmgröße maßgefertigt. Natürlich können Sie auch hier auf alle Gestaltungsmöglichkeiten, wie z. B. Stoff, Farbe, und Druck zugreifen.

ERSATZBEZÜGE

Auch der schönste Bezug verblasst je nach Grad der Bewitterung irgendwann einmal. Dank der extremen Haltbarkeit unserer Schirmgestelle müssen Sie deswegen aber keinen neuen Schirm kaufen. Wir bieten für alle Gestelle Ersatzbespannungen an.

As individual as our customers are our umbrellas. Therefore we offer a variety of customising options - also in the textile range. Classic or modern, discreet or remarkable - the choice is up to you.

COLOURS

The colour of each umbrella can be chosen from a variety of more than hundred standard colours. On demand, we would like to send you our colour charts. Please view at the top a small extraction of our wide variety of stock colours.

RAIN GUTTERINGS

For the types Royal Eagle and XXL we offer textile gutterings to achieve a one-piece protection against the elements by connecting two or more square parasols.

DROP SHEETS

On customer's option, the parasol types Royal Eagle and XXL can be equipped with textile drop sheets. The drop sheets are made to order, so that windows and doors can be designed to match your requirements.

ALL WEATHER COVER BAGS

Made from high quality Airtex providing your umbrella good protection against the elements, especially when situated outdoor during the whole year. Our cover bags are made to order for any parasol size. Also the cover bags can be customised by the choice of fabric, colour and printing.

REPLACEMENT CANVASES

At some point even the best canvas starts fading. But because of the extreme durability of our frames, this shall not be a reason to buy a new umbrella. For all our frames we offer replacement canvases.

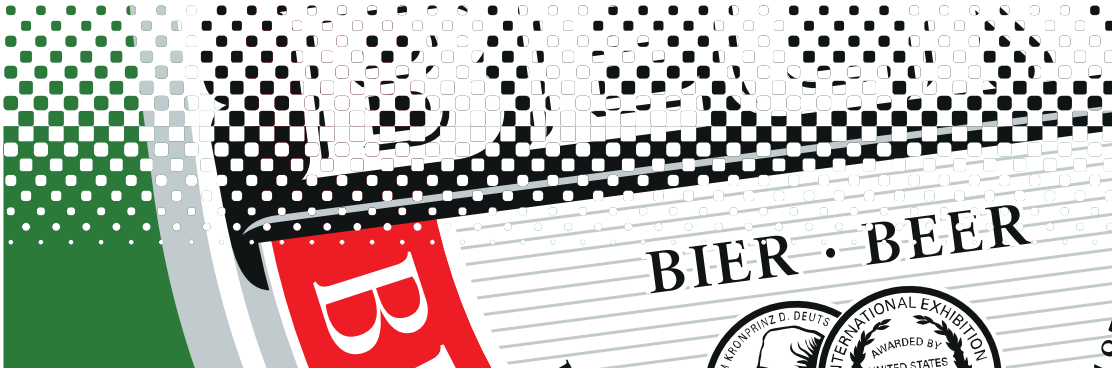

Drucktechnik

Werbedruck für
individuelle Kundenwünsche

Printing techniques

Advertising printing for
individual customer wishes

Damit sich Ihr Unternehmen von der besten Seite zeigen kann, präsentieren wir Ihren Werbedruck von allen Seiten gut sichtbar in bestechender Qualität. Ob ein einzelner Schirm für die Gastronomie oder tausend Schirme für die Industrie - wir bieten Ihnen für jeden Bedarf die richtige Technologie, um kosteneffizient zum perfekten Ergebnis zu gelangen.



Siebdruck | screen printing

- keine Mindestauflagemenge, Druck erfolgt auf bereits zugeschnittenen Stoffen
- brillante Druckergebnisse
- hohe Lichtechtheit der Druckfarben
- Druck auf jeder Stoffklasse und -farbe möglich
- no minimum order quantity
- brilliant results
- high light fastness
- printing is possible on any fabric type or colour

To present your company from its best side, we present your advertising print highly visible from all sides in impressive quality. Whether a single umbrella for the gastronomy or a thousand umbrellas for the industry for each demand we present the right technology, to achieve a perfect result at high cost efficiency.



Digitaldruck | digital printing

- keine Mindestauflagemenge
- ideal für vielfarbige, aufwendige Designs bei kleinen Auflagen
- sehr hohe Lichtechtheit
- Druck auf speziellen Digitaldruck-Textilien,
- Grundfarbe der Stoffe ist immer weiß, sodass hier bei Bedarf der komplette Schirmbezug bedruckt werden kann
- no minimum order quantity
- brilliant results
- very high light fastness
- printing on special fabrics, primary colour of fabric
- needs to be white, whole fabric can be printed at
- customer's option

Dispersionsdruck und Pigmentdruck dispersion printing and pigment printing

- chemisches Dampfdruckverfahren
- perfekte Farbbrillanz und vollständiger Durchdruckeffekt
- sehr hohe Lichtechtheit
- Druck auf speziellen Polyesterstoffen, die komplett eingefärbt werden können
- ideal für Auflagen mit besonderen Ansprüchen
- chemical vapor pressure printing technique
- perfectly brilliant results and complete print through effect
- very high light fastness
- printing on special polyester fabrics that can be coloured at customer's option
- ideal for orders with specific requirements

Elektro Electrics



Für unsere Spitzenbaureihen Royal Eagle (mit Kurbelgetriebe) und XXL bieten wir den Festeinbau von Beleuchtung und Heizung an. Dabei können alle Komponenten sowohl für sich alleine als auch in Kombination gewählt werden. Die Kabel werden im Schirmmast integriert, die Endgeräte werden an einer Verteilerkrone am Schirm angeschlossen. Die Verkabelung außerhalb des Schirms erfolgt in der Regel unterirdisch. Die wasserdichten Anschlüsse sind sicher im Erdreich verborgen und für Unbefugte nicht zugänglich. Ebenso ist eine Überflur-Verkabelung möglich, entweder in Verbindung mit einer Standardbodenhülse oder mit einem mobilen Tophoven-Schirmständer.

For our high end umbrella types Royal Eagle (with winder system) and XXL we offer an installation of lighting and heating. It is possible to choose each as a single component or in combination with other components. The cables are fully integrated to the mast, the devices are plugged into a special hub on the parasol. The wiring away from the parasol is usually under ground, using a special ground base that also keeps the waterproof plug in a safe place so that unauthorised access can be ruled out. An overground wiring, using a standard ground base or a mobile stand is also possible.



Beleuchtung | Lighting

Je nach Wunsch können unsere Schirme mit Energiesparlampen, die fest am Mast montiert werden, oder aber mit schwenkbaren Halogenspots bestückt werden.

On demand our parasols can be equipped with energy saving OSRAM lamps or free adjustable spotlights.

Heizung | Heating

Unsere Schirme können mit bis zu 4 Heizstrahlern ausgerüstet werden, um einen 360° Wirkungskreis zu erzielen.

Our umbrellas can be equipped with up to four IR Heaters to achieve a 360° warming effect.

Kombinationsmöglichkeiten | possible combinations



Kabelführungsvarianten bei Schirmen mit Elektroinstallationen wiring options at umbrellas with electrical installations

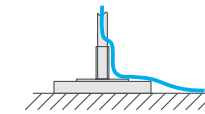

Ständer Überflur
mobile base / overground

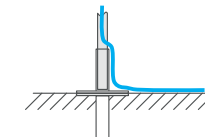

Bodenhülse Überflur
standard ground base / overground

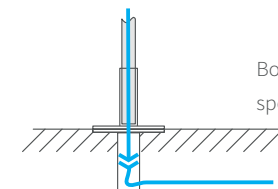



Bodenhülse Unterflur
special ground base / underground





Aufstellvarianten Bases and stands

Wir bieten für unsere Schirme eine Vielzahl verschiedener Bodenhülsen und Schirmständer an.

We offer a wide range of different ground bases and mobile umbrella stands.

Bodenhülsen Ground bases	erhältlich für available for	
Standard standard	Capri, Bali, Nizza, Royal Eagle, XXL, Stormbreaker, Bambrella Levante	
mit Kabelführung for electrics	Royal Eagle, XXL, Stormbreaker	

mobile Schirmständer mobile umbrella stands	erhältlich für available for	
Stahlrahmenständer steel frames	Capri, Bali, Nizza, Royal Eagle, XXL, Stormbreaker, Bambrella Levante	
Stahlplattenständer steel stands	Capri, Bali, Nizza, Royal Eagle, XXL, Stormbreaker, Bambrella Levante	
Betonständer concrete bases	Capri, Bali, Nizza, Bambrella Levante	

Schon gewusst? Wir bieten auch ...



Windschutzwände

- ❖ für Bistros und Lokale in Fußgängerzonen, Ladenpassagen und zu Hause
- ❖ Viele verschiedene Befestigungsmöglichkeiten für mobilen, saisonalen oder ganzjährigen Einsatz
- ❖ verbinden Sie stilvolles Ambiente für Ihre Gäste mit dezent gehaltener Werbung
- ❖ Lassen Sie Wind und Lärm einfach draußen und verlängern Sie Ihre eigene Freiluftsaison
- ❖ verschiedene Modelle und Farben

- ❖ For bistros and restaurants in pedestrian areas, shopping centres or at home
- ❖ A variety of fitting solutions for mobile, seasonal or permanent installation
- ❖ The perfect advertising platform for commercial customers
- ❖ Leave the wind and noise outside and extend the outdoor season
- ❖ Many different sizes, shapes and colours



Beachflags





already known?
we also offer ...



Schirmbeleuchtungen zum Nachrüsten

- ❖ Kabelfreie LED-Beleuchtungen
- ❖ Lange Akku-Laufzeiten
- ❖ Unkomplizierte Montage und einfaches handling
- ❖ Optional mit Farbwechsler

Retrofit parasol lighting

- ❖ No cables - LED lights
- ❖ Long lasting batteries
- ❖ easy attachment and handling
- ❖ Optionally with colour changer



